



Technical Description



- Heated display case with integrated steam generator
- Constant humidification of the food
- Operation of the steam generator via the pictogram control unit
- 3 heat sources: moist heat, infrared supporting heat and primary heat – settable by means of pictogram control
- Use as display case with service or for self-service through slide-in front glass
- Operator side with removable and mirrored hinged doors made of one-way mirrors
- Removable cutting board made of Poly-Hygiene with integrated fold-up mirror underneath
- Long-lasting and heat-resistant LED lighting with warm colour reproduction
- Varied presentation of the food through different accessories such as GN trays
- Standard usable depth up to GN 100 mm; with optional hook-in frame up to GN 150 mm possible
- Basic configuration with GN hook-in frame 100 mm with perforation, dividing bar for GN 2/4 with wind baffle as well as decalcification system
- Made of high-quality stainless steel type 1.4301
- Optional powder coating possible in all RAL colours
- Easiest cleaning and perfect hygiene



TECHNICAL DATA

Subject to change without notice



	COMFORT 78-53	COMFORT 112-53	COMFORT 146-53
Suitable for	GN 2/1	GN 3/1	GN 4/1
Presentation levels	1	1	1
Presentation area	0,35 m ²	0,52 m ²	0,69 m ²
Outside dimensions (in mm)			
Width	785	1125	1465
PRO version: width	775	1115	1455
 Installation opening (in mm)			
Slide-in: width	765	1105	1445
PRO version: width	775	1115	1455
 Performance data			
Power input	2,75 kW	3,4 kW	4,05 kW
Voltage	230 V 50 Hz		400 V 50 Hz

All product illustrations are only symbolic photos. They may differ from the actual units. The specific product properties can be found in the individual product descriptions.



The Highlights



Steam generator: Display case with constant humidification of the food for the highest possible product quality. Operation of the fully-automatic steam generator via the pictogram control system by a simple tap of the finger and immediate response of the humidification.



Once a day: From morning to evening. A tank system in the base provides a water reserve of approximately 12 hours when operated at full load. Easy removal of the water tank for daily filling, as well as acoustic and visual indicator of the water requirement.



Automatic programs: With 7 different automatic programs, perfect results are pre-programmed. Depending on whether you want to keep fish, meat, vegetables or any other food hot in your heated display cases, you can do so with ease thanks to the 7 pre-defined programs.



Pictogram control: Intuitive, easy and fast operation of your climate heated display case thanks to modern pictogram control with humidity, infrared supporting heat and primary heat.



Easy Change: Slide-in front glass, therefore it can be used optionally as a service or self-service display case – in one simple step and without a tool.



Mirror effect: Operator side with mirrored hinged doors made of one-way mirror as well as fold-up mirror for visual multiplication of the selection of food and for optical expansion of the presentation area.

TEMPERATURE RANGE

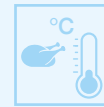

PRODUCT
> +65 °C

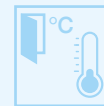

ROOM
+25 °C and
60% rh

OPTIONS			ITEM NO.	PRICE
Without cutting board made of Poly-Hygiene and fold-up mirror	Model 78	Price reduction	529 001	491,00
	Model 112	Price reduction	529 002	618,00
	Model 146	Price reduction	529 003	789,00
Without hinged doors on the operator side	Model 78-53	Price reduction	529 016	341,00
	Model 112-53	Price reduction	529 017	409,00
	Model 146-53	Price reduction	529 018	510,00
Permanent water connection		Surcharge	529 112	556,00
Moveable on casters (height 105 mm) instead of height-adjustable feet		Surcharge	529 120	458,00
Height-adjustable feet for COMFORT Line height 100			529 121	without surcharge
Height-adjustable feet for COMFORT Line height 150			529 122	without surcharge

01 Heated display cases with climate

GLASS ENCLOSURE SQUARED

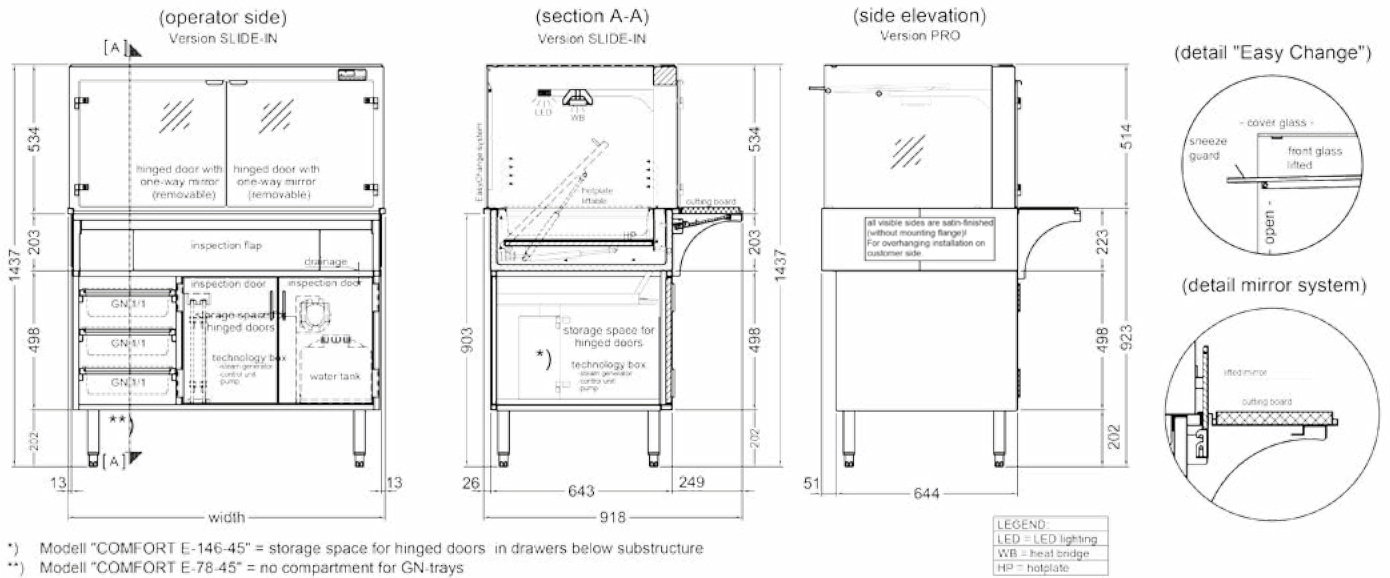

GLASS ENCLOSURE INCLINED

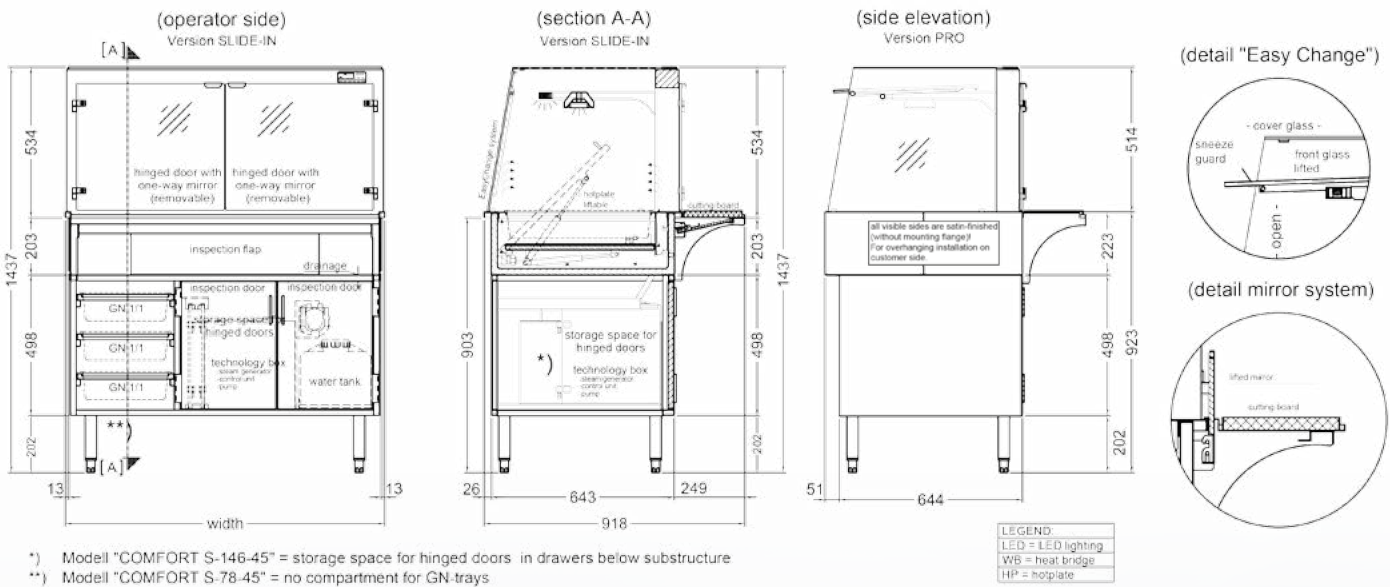

All product illustrations are only symbolic photos. They may differ from the actual units. The specific product properties can be found in the individual product descriptions.