



JOSPER CHARCOAL BROILER OVEN HJX

TECHNICAL INFORMATION

Recommended for ±	175 diners	
Fire up time	40 min average	
Charcoal daily consumption	16 to 20 kg	35 to 44 lb
Performance	9h	
Production per hour	110 kg average	242.5 lb average
Broiling temperature	250 to 350 °C	482 to 662 °F
Grill rack capacity in GN trays	2xGN1/1	
Nominal heat output	9,6 kW	12.9 hp
Flue gas mass flow	23,57 g/s	0.83 oz/s
Net weight	350 kg	771.6 lb

INSTALLATION

Clearance with non-flammable equipment	100 mm	4 in
Clearance with flammable equipment	300 mm	12 in
Exhaust rate	3800 m3/h	2237 cfm

BUNDLES: SIZES AND WEIGHTS

Sizes bundle 1	1010 x 1010 x 1150 mm	39 3/4 x 39 3/4 x 45 1/4 in
Gross weight bundle 1	314 kg	692.2 lb
Sizes bundle 2	1010 x 1010 x 840 mm	39 3/4 x 39 3/4 x 33 1/8 in
Gross weight bundle 2	74 kg	163.1 lb

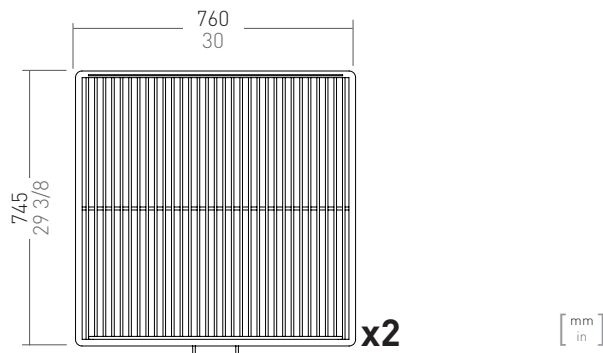

HJX-50-LBC

Josper is an elegant combination of a grill and an oven in a single machine. It works 100% with charcoal. A unique closed barbecue design. Different levels of grilling. Flexible and robust, easy to use, with a front opening door system. Vent system for temperature control.

By bringing the added value that comes from the firewood (charcoal) to the raw material, we obtain those flavours of yesterday, as well as a perfect texture and juiciness. By combining the functions of an oven and grill, we can work at high temperatures, sealing the product, smoking and grilling at the same time. These results are unique, and make the Josper Charcoal Oven a piece of equipment that is also unique.

ACCESSORIES NOT INCLUDED

1 Grill rack · Firebreak · Firebreak hat



Ed.02.2019 - Josper reserves the right to make modifications to catalogues, pricelists and promotional material according to the development and improvements applied to its equipment.

JOSPER CHARCOAL BROILER OVEN HJX

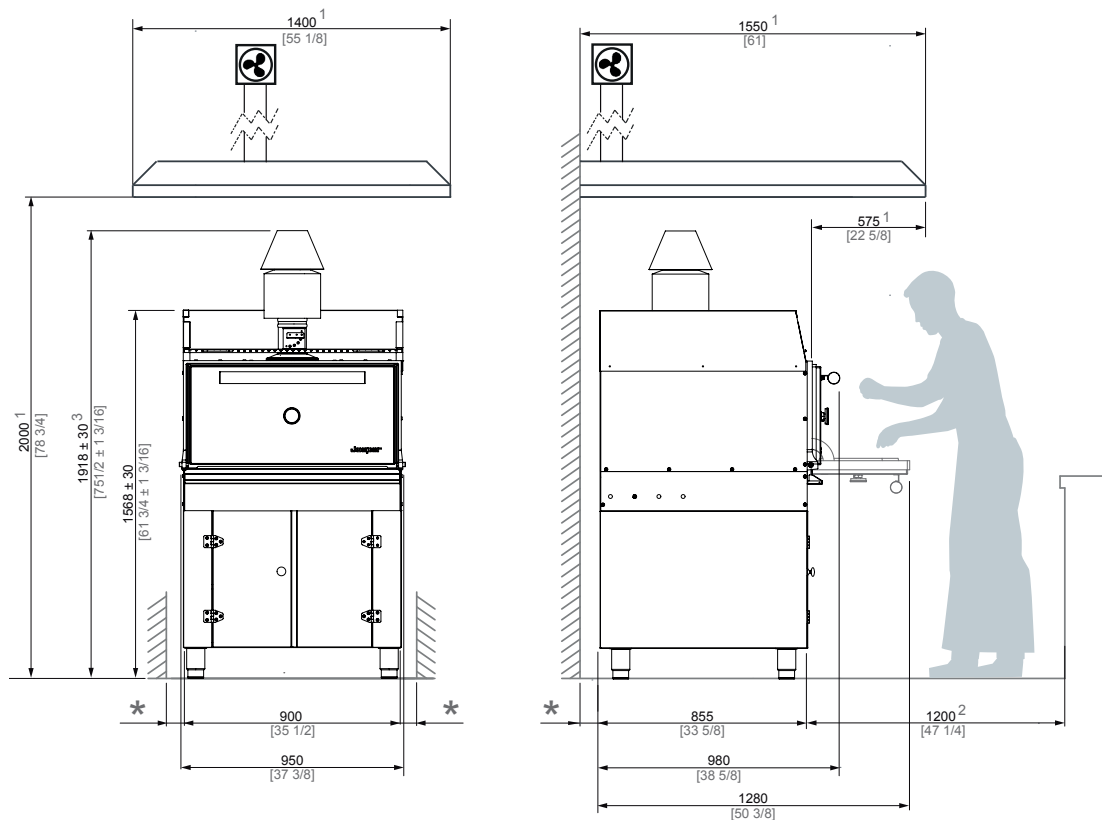
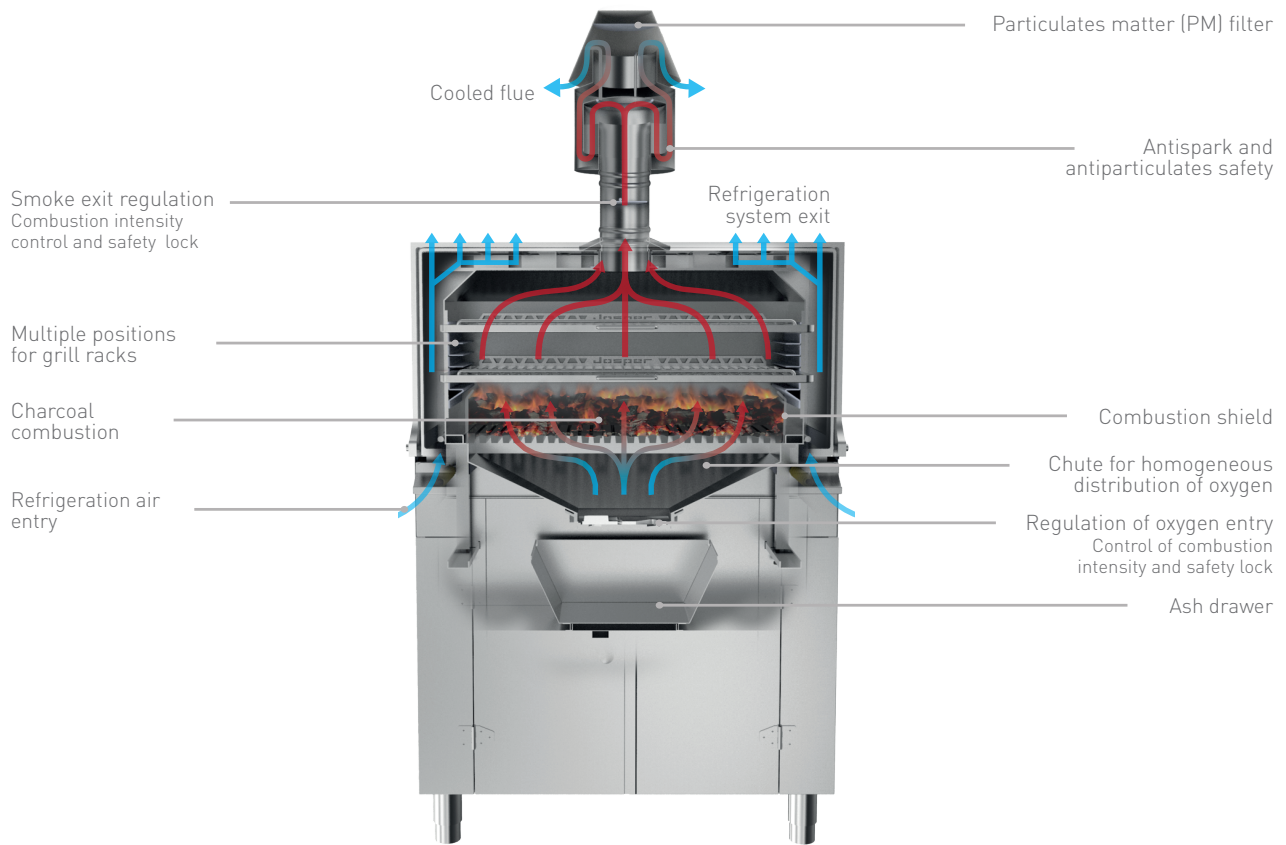

* MINIMUM DISTANCE TO FLAMMABLE ELEMENTS: 300 mm [12 in] / RECOMMENDED DISTANCE TO ANOTHER ELEMENTS: 100 mm [4 in]

1 RECOMMENDED HOOD'S MINIMUM DIMENSIONS

2 RECOMMENDED CHEF'S WORKING SPACE

3 THIS DISTANCE MAY BE MODIFIED BY THE SMOKE OUTLET SET CONFIGURATION.

[mm
in]